

SLE

SLE applications	81
SLE dimensions	82
SLE types	84
SLE sizes	86
SLE parts	87
SLE assembly	88
SLE connectors	83
SLE part numbers	92
SLE accessories	98

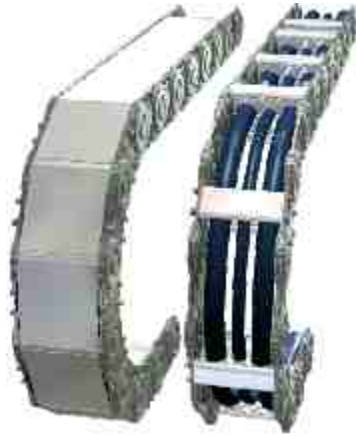

closed + open

SLE CHARACTERISTICS

The SLE is available as **SLA** with aluminium T- or slot-profile, as **SLE** with plastic inserts or plastic slot profile, as **SLS** with foam slot profile, as **SLP** with plastic divider PZ or as **SLR** with pipe or roll stays.



In steel, stainless steel and hardened material is the steel chain in case of large free carrying lengths, large quantities of cables and heavy-duty hydraulic hoses first choice.

- stay distributions in many variants
- stay fast assembly and disassembly
- simple shortening and lengthening
- shroud protecting pivot mechanics

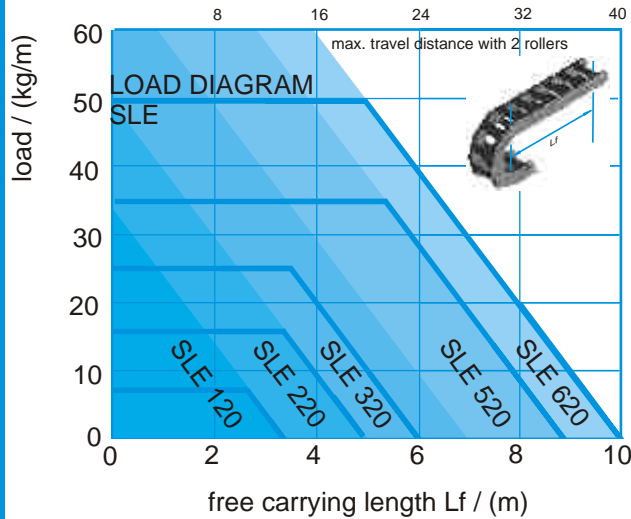

application fields

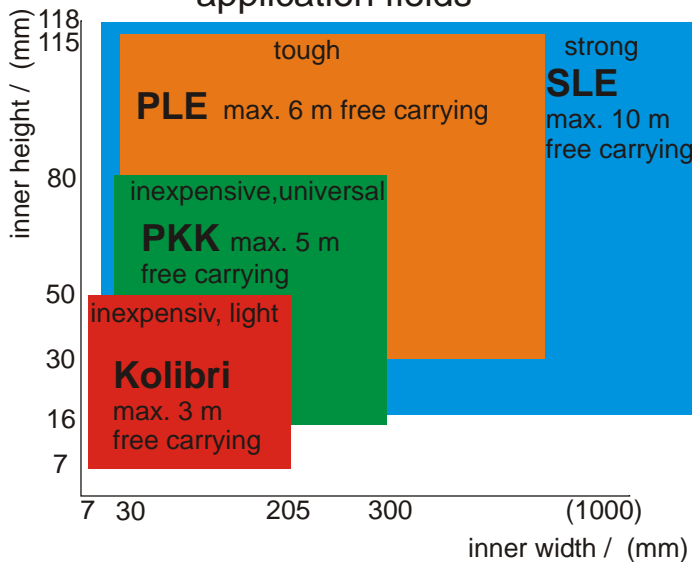

Travel

The maximum travel distance is determined by the arrangement and the additional weight (line weight). At normal arrangement the maximum travel is twice the free carrying length. Support rollers or similar constructive steps can increase this value.

In gliding arrangement travel distances up to 100 meters are possible (application dependent). Exceeding this value additional constructive action is needed (see design guidelines).

Travel speed

The standard and the stainless steel design is limited at 1m/s. Exceeding this and high dynamic loads caused by e.g. vibrations or high number of cycles require the use of the hardened (carburised) material.

Acceleration

The acceleration in principle is not limited. Limits are achieved, by very long chains and line weight that cause extreme tensile forces.

Temperature

The long term operating temperature is -20 °C to 600 °C (-40 °C stainless steel to 600 °C).

Special types

- Stainless Steel
- Carburised (hardened)



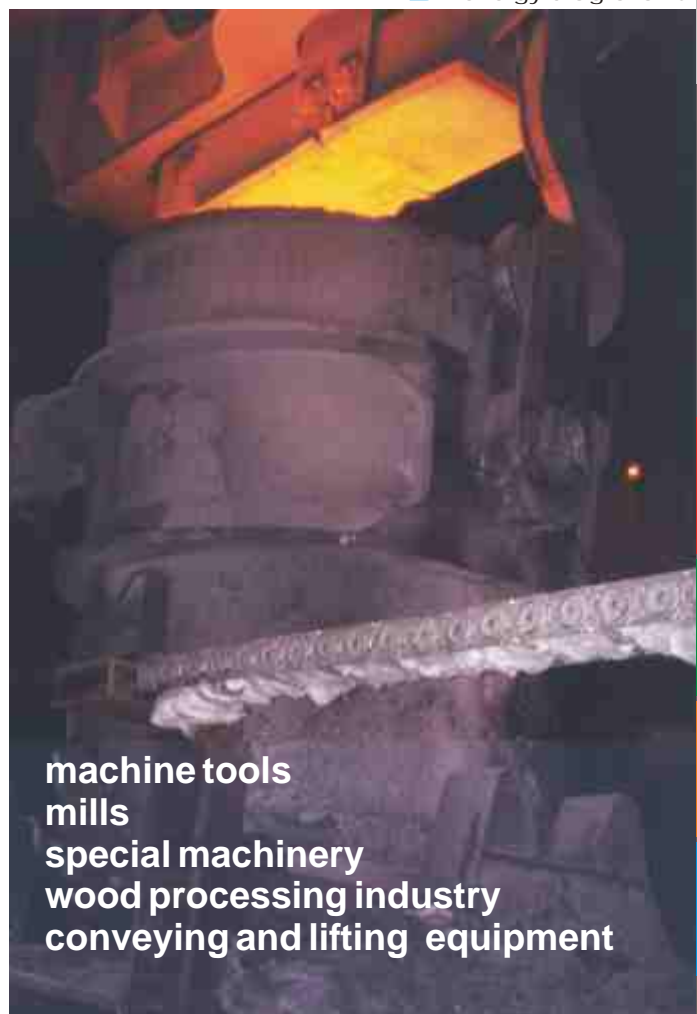

machine tools
mills
special machinery
wood processing industry
conveying and lifting equipment

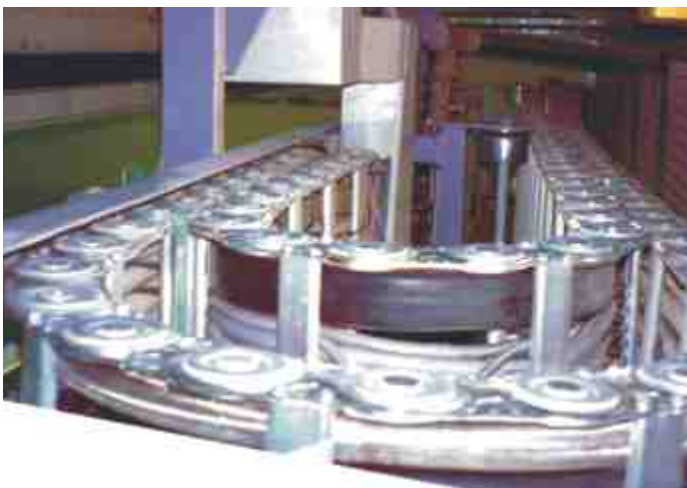

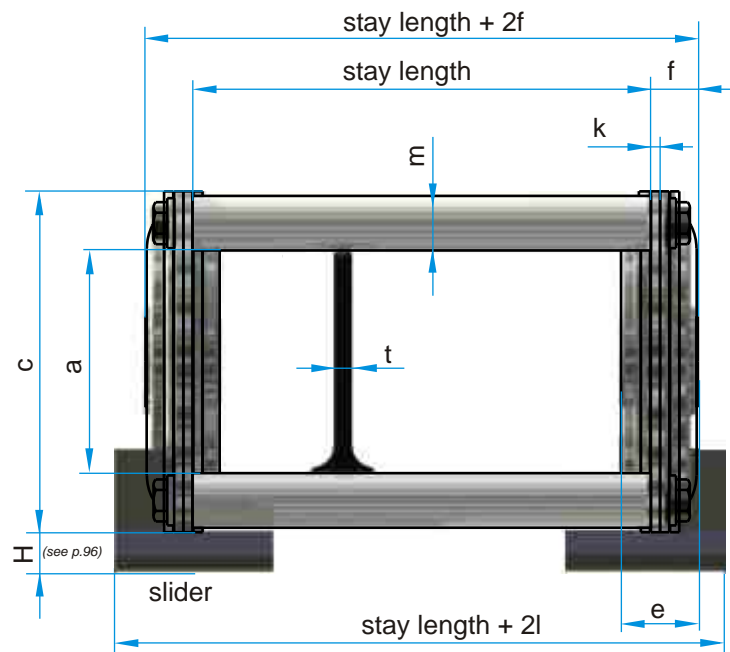

the usable interior width is stay length - 2(e-f)

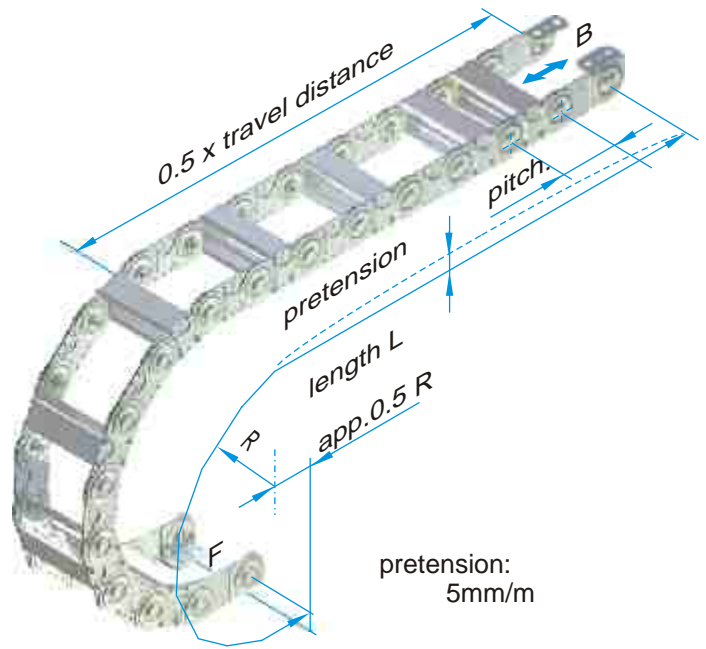

SLE	pitch	a	c	e	f	g	h	k	l ¹⁾	m	o	p	t	weight [kg/m]
120, 121, - , 128	50	20	35	10	6	7,5	7	1	9	7	10	20	4	2.3
220, 221, 225, 228	75	31	50	14	8	12	9	1,5	13	9	12	30	4	4.3 (5.8)
320, 321, 325, 328	100	49	75	17	11	17	11	2	18	12	12	50	4	7.9 (9.6)
520, 521, 525, 528	125	68	100	23.5	15	22	13	3	20	15	12	70	4	15.1 (16.9)
620, 621, 625, 628	175	118	150	23.5	15	26	13	3	20	15	24	115	8	19.3 (20.9)

the weight is given for the standard type with with a stay length of 100, values in brackets for closed version

1) stay length + 2l is the width of the chain with sliders

bending radius R [mm]

120, 121, - , 128			60	100	150		250								
220, 221, 225, 228				100	150	200	250	300							
320, 321, 325, 328 ¹⁾					150	200	250	300	400						
520, 521, 525, 528 ¹⁾						200	250	300	400	500					
620, 621, 625 ²⁾ 628 ¹⁾							250	300	400	500	600				

¹⁾ SLE 328 from R200, SLE 528 from R250, SLE 628 from R300 ²⁾ SLE 625 from R300

the stay lengths are offered in steps of 1 mm

stay length SLE plastic inserts Ø [mm]



120, 121, - , 128	40 ... 800														
220, 221, 225, 228	50 ... 900	10	15	20	25	30									
320, 321, 325, 328	60 ... 1000	10	15	20	25	30	35	40	45	50					
520, 521, 525, 528	70 ... 1200	10	15	20	25	30	35	40	45	50	55	60	65	70	
620, 621, 625, 628	100 ..1200														

order example:

travel distance 3 m, bending radius 200 mm,

cables: 1x15 mm, 8x8 mm, 3x12 mm, 2x22 mm,

normal arrangement

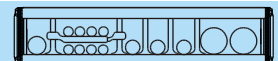

SLP 220 / 200 x 2325 / 200 /N/N¹⁾ / 5 PZ 1 PT55

type / radius x length / stay length / connectors / arrangement / stay distribution

1) 1. fixed connector / 2. moving connector

Normal connector in outer radius

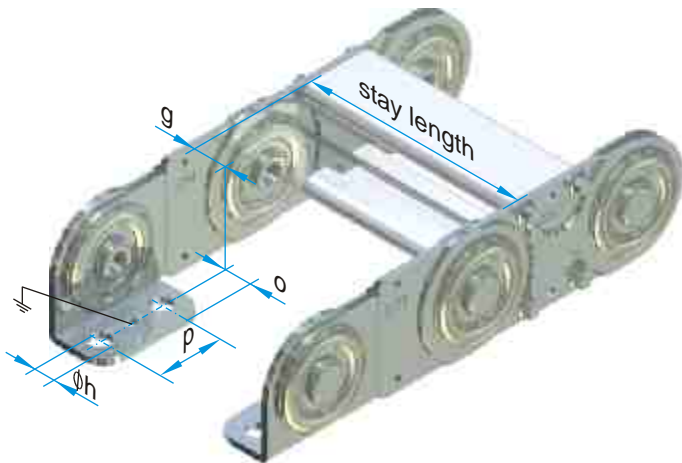

connector **E** in inner radius



SLE	connector screws
120	M 6
220	M 8
320	M10
520	M12
620	M12

connector **A**

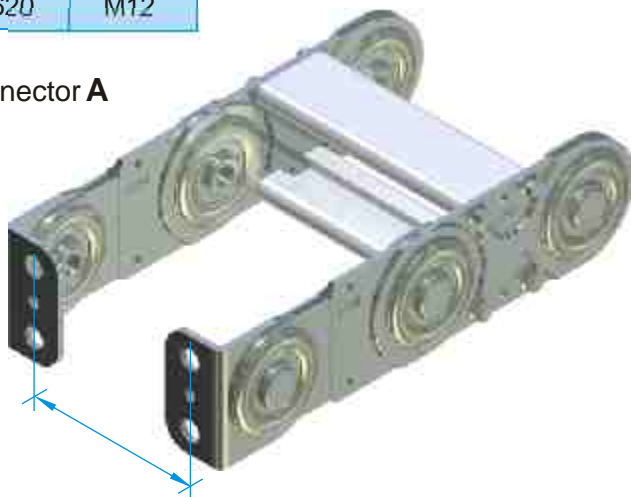

connector dimension = staylength - 2g

connector **B**

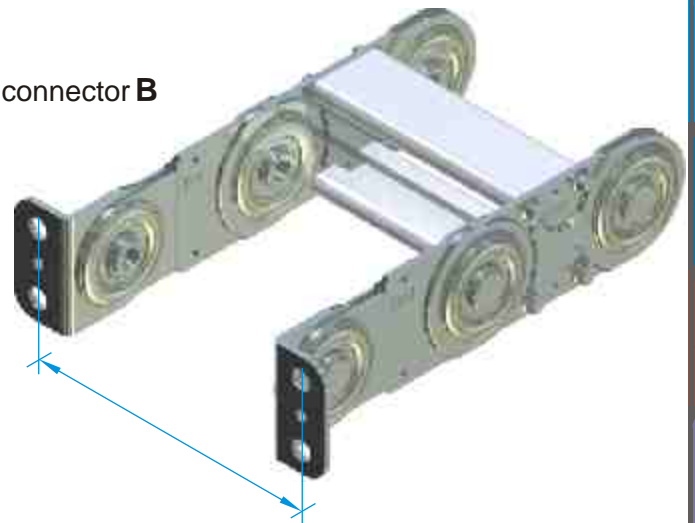

connector dimension = staylength + 2g + 4k

connector **C** in outer radius

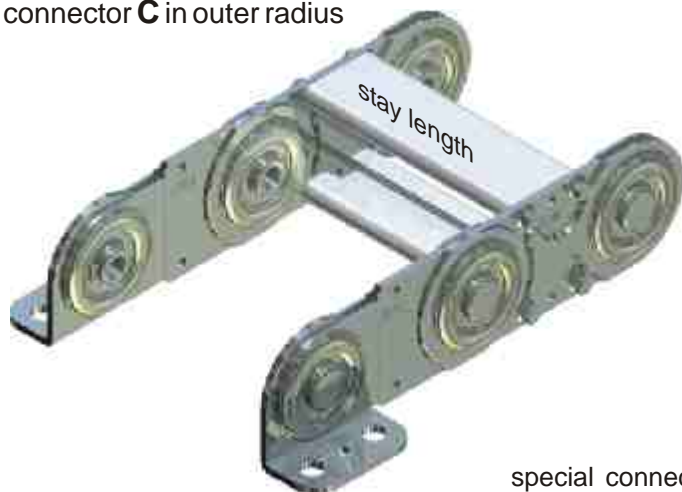

connector **D** in inner radius

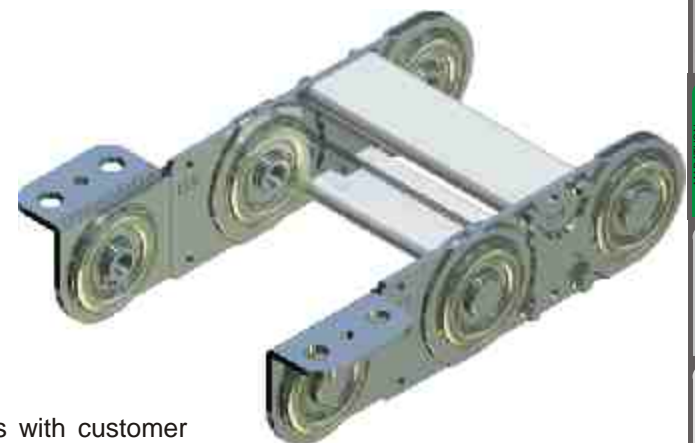

special connectors with customer dimensions are available

SLE TYPES

SLE 120, 220, 320, 520, 620

The standard type is built with stays in every second chain link. The steel link energy chains can be opened in the inner and in the outer bending radius.

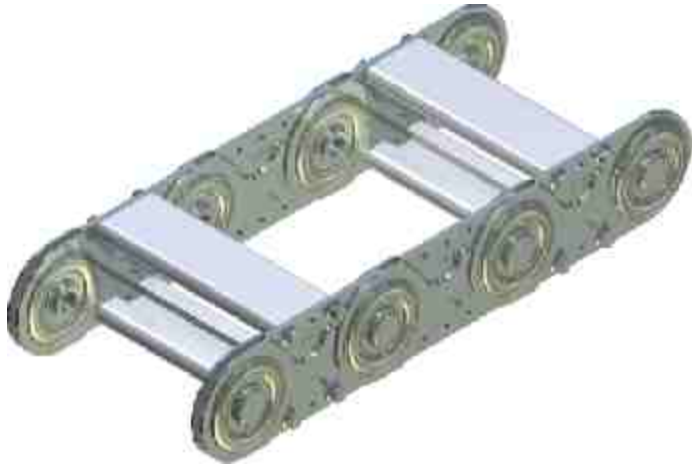

order example

SLP 120	/ 100	x 2050	/ 100	/ D	/ E	/ h	/ 2PZ
type	radius	length	stayw.	connect.	arran.	stay dist.	

SLE 121, 221, 321, 521, 621

These designs are made with stays in each link. This increases the lateral stability and improves the guiding particularly of smaller diameter lines.

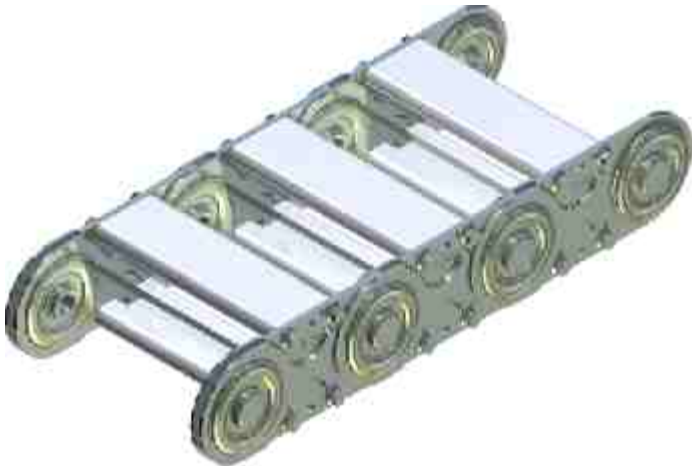

order example

SLP 321	/ 100	x 3100	/ 200	/ N	/ N	/ n	/ 5PZ, 3PT
type	radius	length	stayw.	connect.	arran.	stay dist.	

SLE 225, 325, 525, 625

The closed types offer optimum protection of the lines against dust and cuts or other environmental influences. At higher temperatures the covers **Silver Star** provide excellent protection.

The closed types also may be built to replace the standard version stay.



order example

SLP 225	/ 200	x 2550	/ 150	/ N	/ N
type	radius	length	stayw.	connectors	

SLE 128, 228, 328, 528, 628

These types are suitable for long travel, the upper strand slides on the lower strand. For greater stability these energy chains are built with stays in each link. The energy chains are fitted with sliders, which have a very low coefficient of friction ($\mu = 0.2$ to 0.25).

After reaching the wear limit the slider can be renewed and the energy chain will continue.

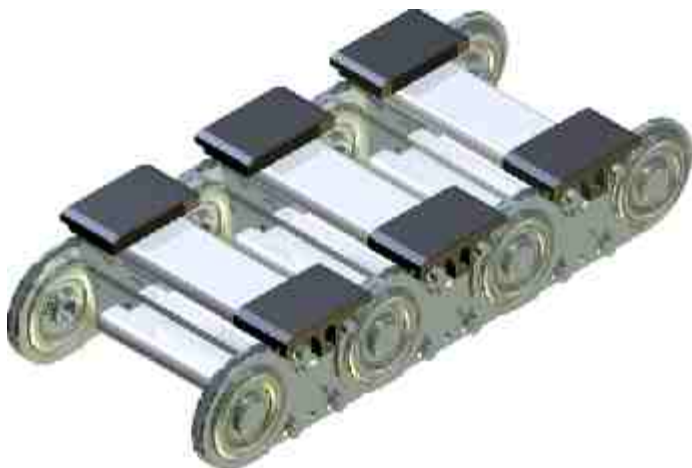

order example

SLP 328	/ 200	x 45000	/ 250	/ N	/ N	/ g	/ 3PZ
type	radius	length	stayw.	connect.	arran.	stay dist.	

Compared to standard chains the SLE series is characterized by the fact that the sturdy aluminium profile can be steplessly adapted to the requirements. Stay lengths of up to 1500 mm can be provided. The subdivision of the interior satisfies every requirement and guarantees optimized cable protection, even at very high accelerations and travel speeds.

The **SLA** (SLE with aluminum T-profile or aluminium slot-profile) is a highly customized and robust energy chain, which is chosen primarily for larger dimensions. The stays are milled in accordance with the requirements of the user with individual hole patterns.

For extreme applications, the variants SLA, SLS and SLE should be preferred, since these offer optimize cable guiding. In the case of high speed and acceleration a multi-layer arrangement of the cable should be avoided.

The **SLE** (SLE with plastic inserts or plastic slot-profile) ensures at high speeds a perfect guide and almost excludes errors during installation of the lines. With this design the hole pattern of the stays can be adjusted accurately to the needs of the lines. Plastic inserts are available in a 5 mm grid. The plastic slot-profile can be ordered to suit special requirements.

For limited installation space, the **SLS** (SLE with foam slot-profile) are used. Again, the optimal guiding of the lines at high speeds and acceleration is ensured. Well-known automotive manufacturers have used this type for years with the best experiences. All lines lie in the neutral axis of the energy chain.

For space reasons, the **SLP** (SLE with plastic divider PZ and others) can be selected. This inexpensive design allows the guiding of large amounts of cable. The highly variable distribution possibility through small steps of (3mm) in height, plus the Telescopic divider (PT) allows maximum space for all needs, even when changes in cable diametres are required.

The **SLR** (SLE with a pipe or roll stays) is manufactured only upon request. The pipe stay allows special material combinations, such as the exclusion of aluminum or the use of stainless steel and brass. The roll bar has advantages particularly for heavy lines with high friction and wear in terms of durability of the cables and hoses: Relative movements on the energy chain are compensated by the rolling motion of the stays.

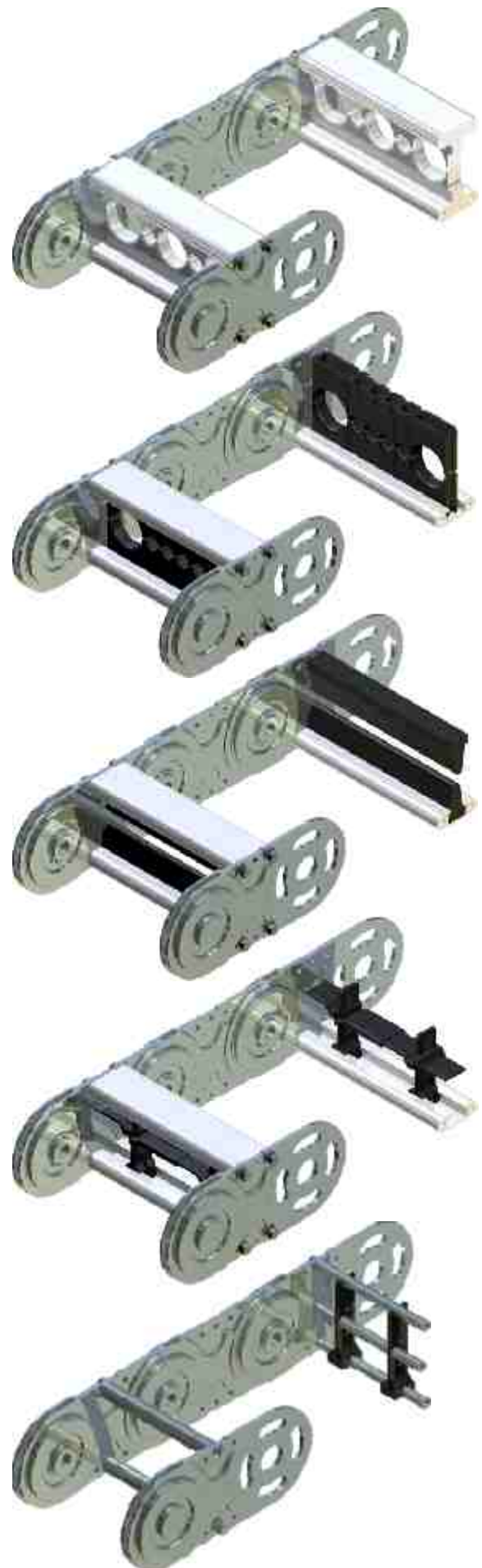

SLE SIZES



SLE 120

standard type			
height:	35	width:	52 ... 812
inner height:	20	inner width:	32 ... 792
		stay length:	40 ... 800



SLE 220

standard type			
height:	50	width:	66 ... 916
inner height:	31	inner width:	38 ... 888
		stay length:	50 ... 900



SLE 320

standard type			
height:	75	width:	80 ... 1020
inner height:	49	inner width:	50 ... 990
		stay length:	60 ... 1000

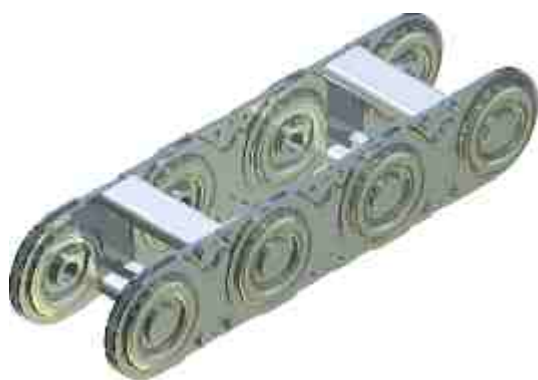

SLE 520

standard type			
height:	100	width:	98 ... 1028
inner height:	68	inner width:	54 ... 1184
		stay length:	70 ... 1500



SLE 620

standard type			
height:	150	width:	128 ... 1228
inner height:	118	inner width:	84 ... 1184
		stay length:	100 ... 1500

Packaging

ekd energy chains are supplied in secured device packaging. When removing the packaging and moving the energy chains or parts of them, ensure that the energy chains are free of torsion and tension to avoid mechanical damage.

Lengthening or shortening

If energy chains are delivered in pieces, proceed with the installation as follows:

Push the link together (1) and insert the flange bolts (5) with a shroud (7) in the chain outside. Then build the radius by inserting the radius bolts (6) (see chart for correct radius). Finally put on the inner shroud (7) and fit the retaining ring (8). Roll the energy chain to check that the radius is correct throughout its length.

Shortening in the reverse order:

Loosen the retaining rings (8), pull out the flange bolts (5), lifting the shroud (7), pull the radius bolts (6) and remove the links (1).

Energy chains with threaded bolts instead of the retaining rings (8), first unlock the locking plates (18) to solve the locknuts (19). Thereafter, the threaded bolts (17) and pins (6) can be removed and taken from the links (1).

Implement the connector angle

The connector angles (4) are orientated to the outer radius and to the chain center (normal end mounted). By loosening the retaining rings (8), drag the flange bolts (5), lift off the shroud (7) and pull the radius bolts (6) the connector angles (4) can be disassembled and placed in a different position.

Bending radius

Loosen the retaining rings (1) and lift off the shrouds (7). Implement the radius bolts (6) according to table (page 89). Then mounting the shrouds (7) and retaining Rings (1).

The detachable bolts position for the different radii can be found engraved on the double connector links (3).

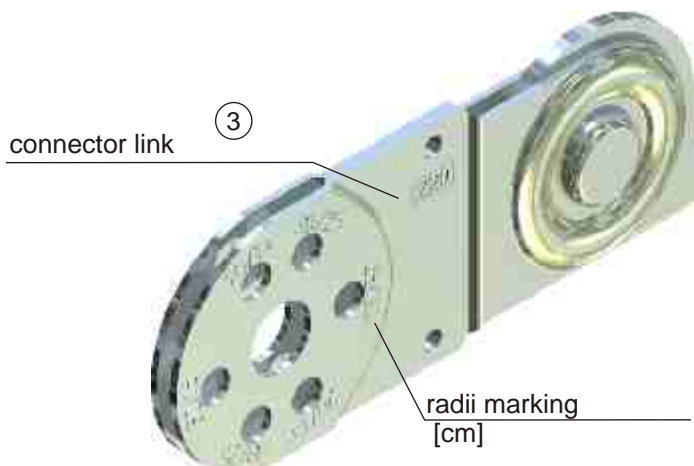
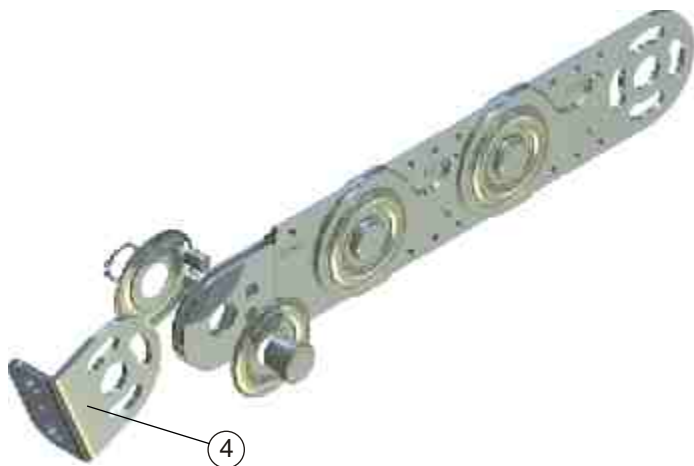
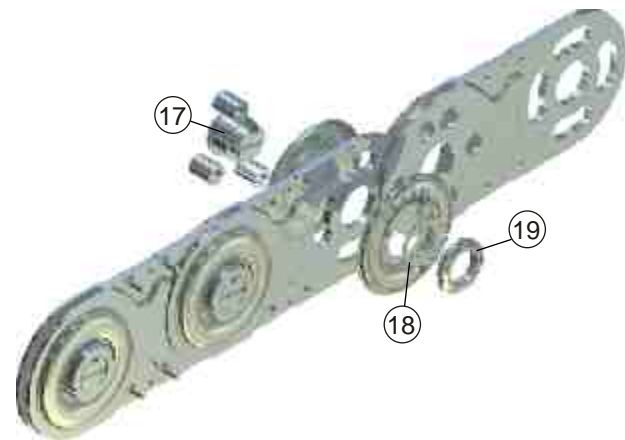
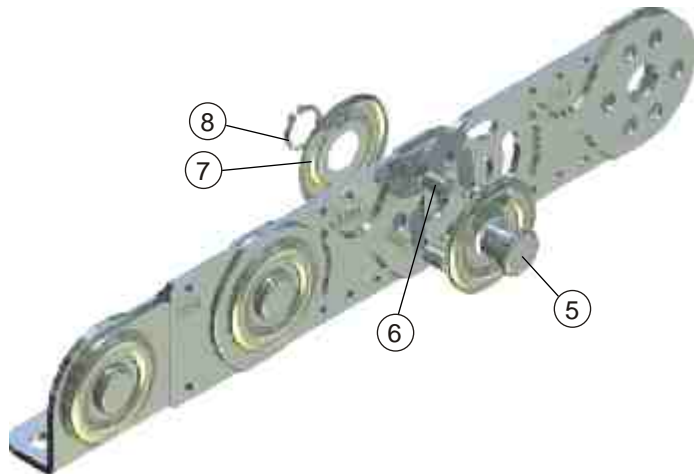

assembly of radius bolts

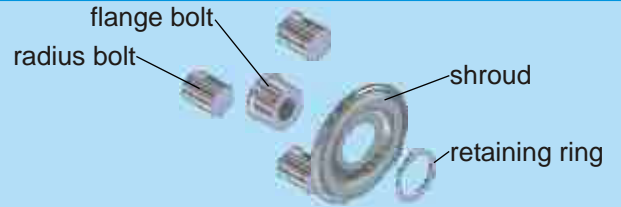

SLE **120** **220** **320** **520** **620**

radius	60	100	150	200	250	<p>(marking in the outer radius)</p> <p>the minimum radius is built with only 2 bolts</p>
radius	100	150	200	250	300	<p>(marking in the outer radius)</p>
radius	150	200	250	300	400	<p>(marking in the outer radius)</p>
radius	250	250	300	400	500	<p>(marking in the inner radius)</p>
radius	-	300	400	500	600	<p>(marking in the inner radius)</p>

Stay removal

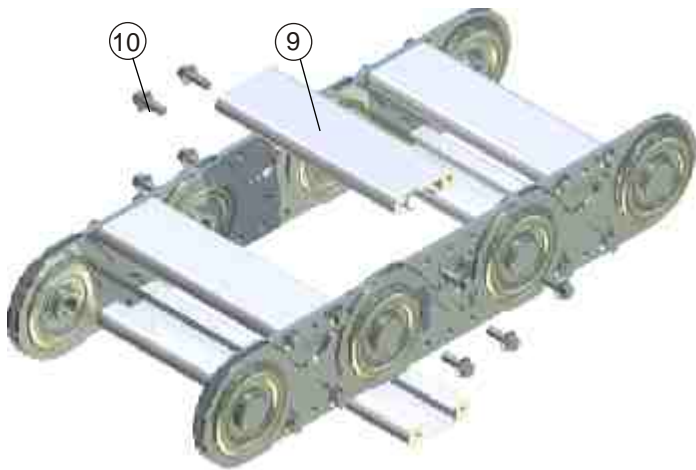

The stays (9) are fastened with serrated screws (10) to the links (1). They can be removed by unscrewing the four screws (10).

Stay lengths up to 600 mm are available with quick assembly.

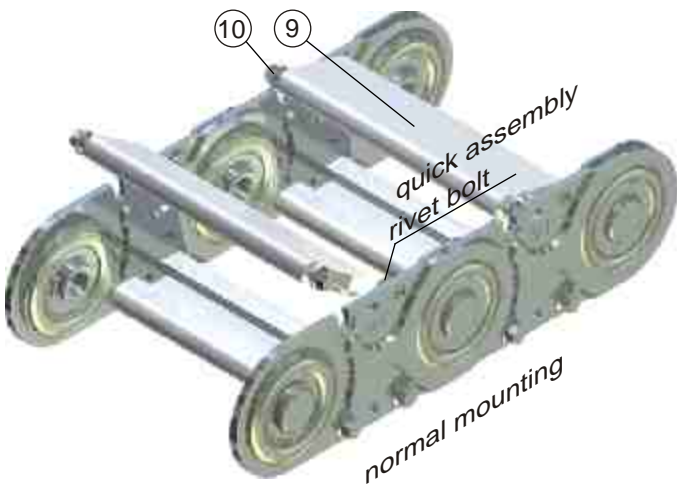

Quick assembly

In quick assembly only two screws must be tightened or loosed. The stays (9) are moved with the groove on the rivet and the serrated screw (10) snapped in the recess and tightened.



Cover Silver Star

The covers of the closed version can be removed like the stays by loosening the four serrated screws (10). The spacers (13) remain on the links.

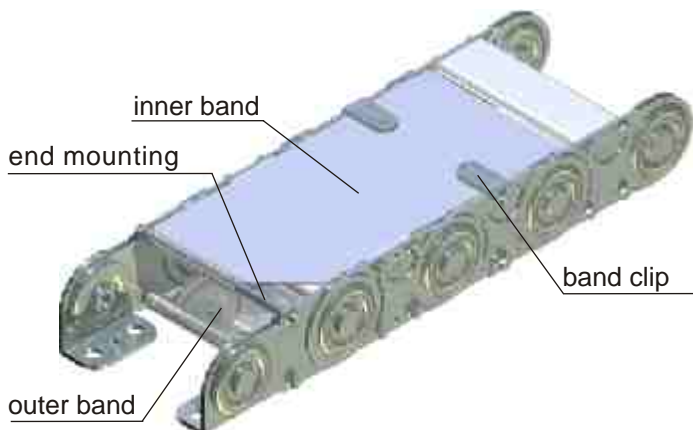

Stainless steel bands

To protect the lines against external damage and pollution the chains can be equipped with steel or stainless steel bands in the inner and outer radius. The edges of the steel bands are circular smoothed to avoid injury. Stainless steel and steel bands are fastened with band holders screwed on sides and with screwed connections on each end of the chain.

Final assembly

The installation height should not fall below the level $H = (50 \text{ plus two times bend radius plus link height})$.
The pretension of cable carrier is taken into account with the additional space of 50 mm.

First fasten fixed connection (F) and then mount the movable connection using the specified bolt size (see SLE connectors).
Compliance with the maximum free carrying length is of vital importance for the life time of the energy chain, both during the installation as well as when operational. Over travel of the energy chain can lead to damage and premature wear.

If the energy chain is provided with support elements, the assembly of these must take place before the installation of the chain in order to avoid even a short-term stress point.

An energy chain may never exceed the free carrying length without support rollers.

The height of the moved connector must be adjusted so that the connector link is moving with a maximum of 5 mm distance from the base of the supporting roller.

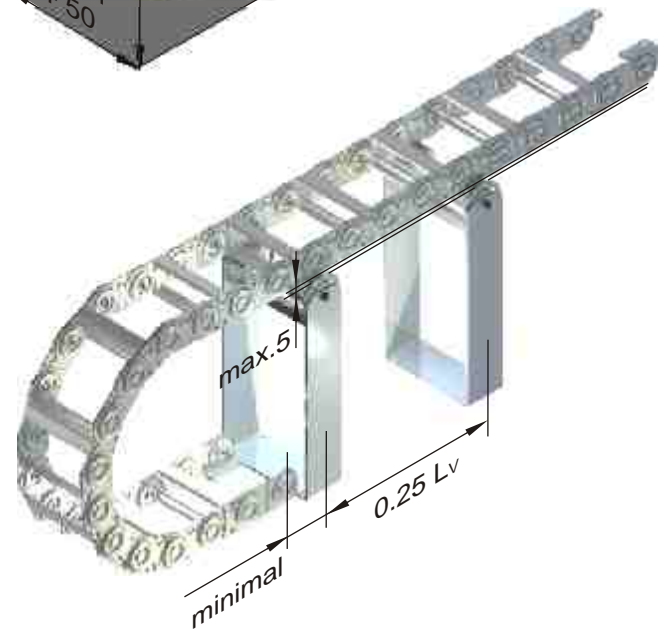
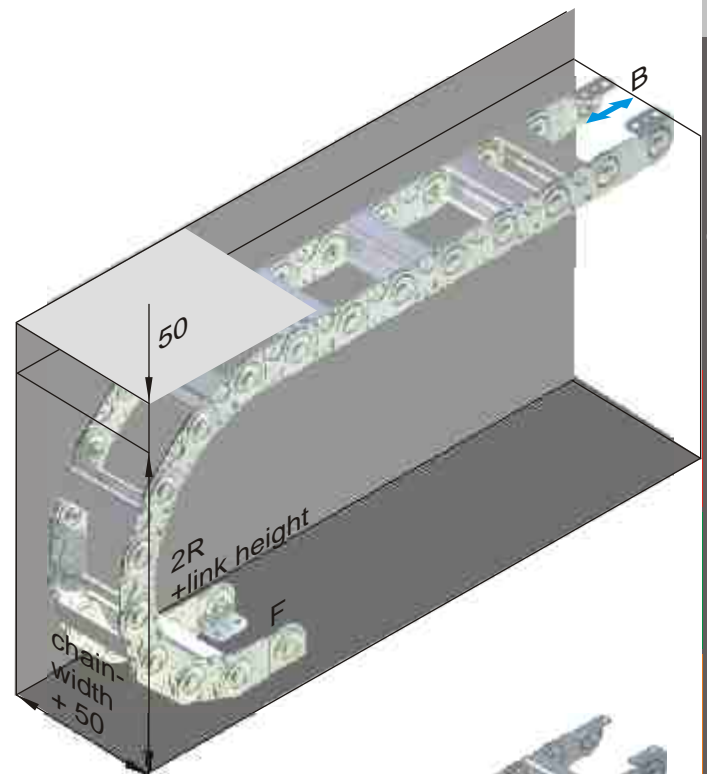

Maintenance of the energy chain

PLE energy chains are maintenance free. Like every mechanical system this will depend on the ambient conditions so wear will occur which must be observed.

In case of the energy chain has to be exchanged.

For long travels or in a circular motion, the energy chains are often equipped with sliding elements. These allow sliding of the upper part of the chain on a suitable surface (eg, slider-slider, slider-steel, glide bar).

The sliders wear depends on the application. The slider surfaces should be checked at regular intervals. With a thickness of 1-2 mm sliders have to be replaced.

SLE parts 87 **1**



SLE link

special material parts like U194 V-0, EX or other have to be named in the order



connector link single



connector link double



connector angle

	R 60, 100, 150, 250												
	galv.	carbur.	Stainl.steel	galv.	carbur.	Stainl.steel	galv.	carbur.	Stainl.steel	galv.	carbur.	stainl.steel	
120	0110	-	1738	0104	-	-	0105	-	-	0064	-	1732	
121	0110	-	1738	0104	-	-	0105	-	-	0064	-	1732	
128	0110	-	1738	0104	-	-	0105	-	-	0064	-	1732	
	R 100, 150, 200, 250, 300												
	galv.	carbur.	Stainl.steel	galv.	carbur.	Stainl.steel	galv.	carbur.	Stainl.steel	galv.	carbur.	stainl.steel	
220	0117	0821	1739	0115						0114			
221	0117	0821	1739	0115						0114			
225	0117	0821	1739	0115						0114			
228	0117	0821	1739	0115						0114			
	R 150, 200, 250, 300, 400												
	galv.	carbur.	Stainl.steel	galv.	carbur.	Stainl.steel	galv.	carbur.	Stainl.steel	galv.	carbur.	stainl.steel	
320	1890	1725	1726	0145		1720	0146		1721	0144		1719	
321	1890	1725	1726	0145		1720	0146		1721	0144		1719	
325	1890	1725	1726	0145		1720	0146		1721	0144		1719	
328	1890	1725	1726	0145		1720	0146		1721	0144		1719	
	R 200, 250, 300, 400, 500												
	galv.	carbur.	Stainl.steel	galv.	carbur.	Stainl.steel	galv.	carbur.	Stainl.steel	galv.	carbur.	stainl.steel	
520 / 510	0175	/ 0703	1727	1730	0173		1689	0174		1690	0172		1536
521 / 511	0175	/ 0703	1727	1730	0173		1689	0174		1690	0172		1536
525 / 515	0175	/ 0703	1727	1730	0173		1689	0174		1690	0172		1536
528 / 518	0175	/ 0703	1727	1730	0173		1689	0174		1690	0172		1536
	R 250, 300, 400, 500, 600												
	galv.	carbur.	Stainl.steel	galv.	carbur.	Stainl.steel	galv.	carbur.	Stainl.steel	galv.	carbur.	Stainl.steel	
620	1891		-		0877			0876			0884		
621	1891		-		0877			0876			0884		
625	1891		-		0877			0876			0884		
628	1891		-		0877			0876			0884		

Standard-links are produced without band clip cut out. Energy chains with band cover have to be ordered with the following article numbers: SLE 320 0147 , SLE 520 2004 , SLE 620 0878

SLE PART NUMBERS



SLE parts 87

SLE shroud retaining ring radius bolt flange bolt C-profile T-profile ASA / ASI distance filler serrated screw

St VA St CuSn St VA links rechts

120	0107	-	0109	-	0106	-	0108	-	0692	-	-	-	-	0127 (M4x12)
121	0107	-	0109	-	0106	-	0108	-	0692	-	-	-	-	0127
128	0107	-	0109	-	0106	-	0108	-	0692	-	-	-	-	0127
220	0119	0137	0118	0136	0120	0121	0122	0134	0124	0141	-	-	-	0127 (M4x12)
221	0119	0137	0118	0136	0120	0121	0122	0134	0124	0141	-	-	-	0127
225	0119	0137	0118	0136	0120	0121	0122	0134	-	-	1065	1066	1670	1404
228	0119	0137	0118	0136	0120	0121	0122	0134	0124	0141	-	-	-	0127
320	0149	0166	0148	0167	0150	0151	0152	0165	0154	0171	-	-	-	0157 (M5x14)
321	0149	0166	0148	0167	0150	0151	0152	0165	0154	0171	-	-	-	0157
325	0149	0166	0148	0167	0150	0151	0152	0165	-	-	0847	0846	1293	1671
328	0149	0166	0148	0167	0150	0151	0152	0165	0154	0171	-	-	-	0157
520	0177	0193	0176	0192	0178	0179	0180	1529	0182	0194	-	-	-	0185 (M6x18)
521	0177	0193	0176	0192	0178	0179	0180	1529	0182	0194	-	-	-	0185
525	0177	0193	0176	0192	0178	0179	0180	1529	-	-	0849	0848	1405	1673
528	0177	0193	0176	0192	0178	0179	0180	1529	0182	0194	-	-	-	0185
620	0872		0176	0192	-	0874	0180	-	0182	0851	-	-	-	0185 (M6x18)
621	0872		0176	0192	-	0874	0180	-	0182	0851	-	-	-	0185
625	0872		0176	0192	-	0874	0180	-	-	-	0957	0956	-	0185
628	0872		0176	0192	-	0874	0180	-	0182	0851	-	-	-	0185



SLE PART NUMBERS

special material parts like UI94 V-0, EX or other have to be named in the order

SLE parts 87



SLE PZ



PTF PT 55 PT 75



LS ZL ZLA8 ZLS10 ZHS10 pipe stay

120	0691		0112			-	-	-		1665	1273	1159	1160	1407	D6 739
121	0691		0112			-	-	-		1665	1273	1159	1160	1407	D6 739
128	0691		0112			-	-	-		1665	1273	1159	1160	1407	D6 739
220	0778	1519	0779	1658		1927	0879	0880		1665	1273	1159	1160	1407	D6 740
221	0778	1519	0779	1658		1927	0879	0880		1665	1273	1159	1160	1407	D6 740
225	0778	1519	0779	1658		1927	0879	0880		1665	1273	1159	1160	1407	D6 740
228	0778	1519	0779	1658		1927	0879	0880		1665	1273	1159	1160	1407	D6 740
320	0163	1678	1659	1660		1927	0879	0880		1665	1273	1159	1160	1407	D8 741
321	0163	1678	1659	1660		1927	0879	0880		1665	1273	1159	1160	1407	D8 741
325	0163	1678	1659	1660		1927	0879	0880		1665	1273	1159	1160	1407	D8 741
328	0163	1678	1659	1660		1927	0879	0880		1665	1273	1159	1160	1407	D8 741
520	0719	1679	1661	1662	1680	1927	0879	0880		1665	1675	1159	1160	1407	D8 742
521	0719	1679	1661	1662	1680	1927	0879	0880		1665	1675	1159	1160	1407	D8 742
525	0719	1679	1661	1662	1680	1927	0879	0880		1665	1675	1159	1160	1407	D8 742
528	0719	1679	1661	1662	1680	1927	0879	0880		1665	1675	1159	1160	1407	D8 742
620	1257	1778	1980	-	-	-	-	-		-	1612	1159	1160	1407	D8 742
621	1257	1778	1980	-	-	-	-	-		-	1612	1159	1160	1407	D8 742
625	1257	1778	1980	-	-	-	-	-		-	1612	1159	1160	1407	D8 742
628	1257	1778	1980	2228	-	-	-	-		-	1612	1159	1160	1407	D8 742

SLE PART NUMBERS

plastic inserts

diameter in mm

SLE 10 15 20 25 30 35 40 45 50 55 60 65 70

120	-	-	-	-	-	-	-	-	-	-	-	-	-
121	-	-	-	-	-	-	-	-	-	-	-	-	-
128	-	-	-	-	-	-	-	-	-	-	-	-	-



220	0649	0650	0651	0652	0653	-	-	-	-	-	-	-	-
221	0649	0650	0651	0652	0653	-	-	-	-	-	-	-	-
225	0649	0650	0651	0652	0653	-	-	-	-	-	-	-	-
228	0649	0650	0651	0652	0653	-	-	-	-	-	-	-	-



320	0654	0655	0656	0657	0658	0659	0660	0661	0662	-	-	-	-
321	0654	0655	0656	0657	0658	0659	0660	0661	0662	-	-	-	-
325	0654	0655	0656	0657	0658	0659	0660	0661	0662	-	-	-	-
328	0654	0655	0656	0657	0658	0659	0660	0661	0662	-	-	-	-

























520	1628	0663	0664	0665	0666	0667	0668	0669	0670	0671	0672	0714	0715
521	1628	0663	0664	0665	0666	0667	0668	0669	0670	0671	0672	0714	0715
525	1628	0663	0664	0665	0666	0667	0668	0669	0670	0671	0672	0714	0715
528	1628	0663	0664	0665	0666	0667	0668	0669	0670	0671	0672	0714	0715

620	-	-	-	-	-	-	-	-	-	-	-	-	-
621	-	-	-	-	-	-	-	-	-	-	-	-	-
625	-	-	-	-	-	-	-	-	-	-	-	-	-
628	-	-	-	-	-	-	-	-	-	-	-	-	-

SLE parts 87

special material parts like UI94 V-0, EX or other have to be named in the order

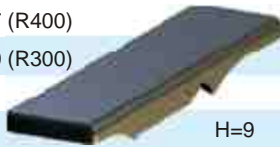
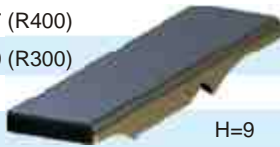

SLE	plastic- insert profile	aluminium insert profile	foam	sliders	flange rollers (complete)
120	-	-	-		
121	-	-	-		
128	-	-	-	1443  H=3,5	
220	0 827 	1649 	0730 	1444 <R200 H=7,5 	0132 
221	0 827	1649	0730	1970 ≥ R200 	0132
225	0 827	1649	0730		0132
228	0 827	1649	0730		-
320	1646 	1650 	0731 	1445 	0162 
321	1646	1650	0731	1448 H=9,5 	0162
325	1646	1650	0731	1955 (Standard) 	0162
328	1646	1650	0731	1968 	-
520	1647 	1651 	0732 	1446 H=9 	0190 
521	1647	1651	0732	1987 H=15 	0190
525	1647	1651	0732		0190
528	1647	1651	0732		-
620	1648 	1652 	-	1447 (R400) 	0190
621	1648	1652	-	2070 (R300) 	0190
6290	1648	1652	-		-
628	1648	1652	-		-

SLE PART NUMBERS

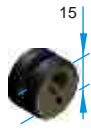

SLE damping element screw nut

double bolt

glide disc

St vz VA

D45

120				0694		0693 0969 (compl.)		
121				0694		0693 0969 (compl.)		
128				0694		0693 0969 (compl.)		

D55

D70

220	2136	0826	0825	0123	0138	0128 0963 (compl.)	0129 0964 (compl.)	
221	2136	0826	0825	0123	0138	0128 0963 (compl.)	0129 0964 (compl.)	
225	2136	0826	0825	0123	0138	0128 0963 (compl.)	0129 0964 (compl.)	
228	2136	0826	0825	0123	0138	0128 0963 (compl.)	0129 0964 (compl.)	

D80

D95

320	0819	2136	0826	0825	0153	1718	0158 0965 (compl.)	0159 0966 (compl.)
321	0819	2136	0826	0825	0153	1718	0158 0965 (compl.)	0159 0966 (compl.)
325	-	2136	0826	0825	0153	1718	0158 0965 (compl.)	0159 0966 (compl.)
328	0819	2136	0826	0825	0153	1718	0158 0965 (compl.)	0159 0966 (compl.)

D105

D120

520	2025	2136			0181		0186 0967 (compl.)	0187 0968 1575 (br.)
521	2025	2136			0181		0186 0967 (compl.)	0187 0968 1575 (br.)
525	-	2136			0181		0186 0967 (compl.)	0187 0968 1575 (br.)
528	2025	2136			0181		0186 0967 (compl.)	0187 0968 1575 (br.)

620	2025	2136						D155 1538	D170 1539
621	2025	2136						1538	1539
625	1999/2000							1538	1539
628	2025	2136						1538	1539

